



**OMEGA**

Tecnologia evoluta a servizio dell'uomo



**PATENTED**

**ATLANTA**

**ATLANTA**  
S T R E T C H

## Il sistema Omega Omega system



- 🇮🇹 Io non necessito di manutenzione. Non ho parti elettriche in rotazione.
- 🇬🇧 Traditional systems require regular maintenance. I have no rotating electrical and less than 50% rotating mechanical parts.
- 🇫🇷 Entretien réduit. Sans composants électriques en rotation.
- 🇩🇪 Ich benötige keine Wartung weil: kein elektronisches Bauteil auf dem rotierenden Folienschlitten habe.
- 🇪🇸 No necesita de mantenimiento. No tiene partes eléctricas en rotación.



- 🇮🇹 Io sono la più veloce di tutte fino a 140 pallet /ora.
- 🇬🇧 I am faster than any other, output capacity up to 140 pallet / h.
- 🇫🇷 Je suis la plus rapide de toutes jusqu'à 140 palettes/heure.
- 🇩🇪 Ich bin die schnellste mit bis zu 140 Paletten pro Stunde.
- 🇪🇸 Es la mas rápida de todas, hasta 140 palets/hora.



- 🇮🇹 Io controllo l'allungamento del film con il mio brevetto e posso variare la tensione dal Display.
- 🇬🇧 I check the output of stretch film with my patented control system and can change the tension on load from Display.
- 🇫🇷 Je contrôle l'allongement du film avec mon brevet.
- 🇩🇪 Ich kontrolliere mit meinem Patent die Vordehnung der Stretchfolie und kann die Anlegespannung vom Display einstellen.
- 🇪🇸 Mediante un sistema patentado controlamos la longitud del film y variar la tensión en el display.



- 🇮🇹 Io posso montare una bobina jumbo (40Kg) per risparmiare tempo e denaro. Posso utilizzare film macroforato.
- 🇬🇧 I can use the Jumbo reel (40 Kg) to save time and money. Suitable also for net film.
- 🇫🇷 Possibilité de bobine jumbo (40kg) pour économiser du temps et de l'argent. Utilisation possible de film macro perforé.
- 🇩🇪 Ich kann auch eine Jumbo Folirolle mit 40 Kg (sowie eine Perforierte Folie) verarbeiten und dadurch wird viel Zeit und Geld gespart.
- 🇪🇸 Se puede utilizar una bobina jumbo (40Kg) para ahorrar tiempo y dinero. Se puede utilizar film macroperforado.



## I vecchi sistemi Old systems



- 🇮🇹 Hanno complicati sistemi di generazione elettrica che richiedono numerose manutenzioni.
- 🇬🇧 They have complicated systems like electric generator to produce electricity and/or need frequent servicing.
- 🇫🇷 Elles ont des systèmes de génération électrique compliqués qui nécessitent nombreuses interventions de maintenance.
- 🇩🇪 Haben komplizierte Systeme um Elektrischen Strom zu erzeugen und sind sehr Wartungsintensiv.
- 🇪🇸 Tiene un complicado sistema de generación eléctrica que requiere mucha manutención.

- 🇮🇹 Non raggiungono i 100 pallet per ora a parità di condizioni.
- 🇬🇧 They are limited to output capacity of 100 pallet / h.
- 🇫🇷 Elles ne rejoignent pas les 100 palettes/heure à égalité de conditions.
- 🇩🇪 Sie erreichen keine 100 Paletten pro Stunde (unter gleichen Bedingungen).
- 🇪🇸 No supera los 100 palets/hora.

- 🇮🇹 Hanno un approssimativo controllo del pre-stiro.
- 🇬🇧 They have an approximate control of pre-stretch system.
- 🇫🇷 Elles ont un contrôle approximatif du pré-étirage.
- 🇩🇪 Haben ein ungenaues System für die Vordehnung der Stretchfolie.
- 🇪🇸 Tiene un control del pre-estiro aproximativo.

- 🇮🇹 Per una maggiore autonomia necessitano di cambio bobina film e i consumi sono maggiori.
- 🇬🇧 For longer autonomy they need frequent film roller exchange with higher consumption.
- 🇫🇷 Pour obtenir une autonomie majeure, ils nécessitent d'un changement bobine film et les consommations sont majeures.
- 🇩🇪 Um eine höhere Autonomie zu erreichen benötigt man ein Autom. Foliwechsel System und haben dadurch höhere Kosten.
- 🇪🇸 Para una mayor autonomía necesita del cambio bobina film y el consumo es mayor.



## Atlanta Stretch S.p.A.

 ATLANTA STRETCH S.p.A è una azienda che si occupa di progettazione, costruzione e commercializzazione di macchine automatiche e semiautomatiche per l'avvolgimento dei pallet con il film estensibile.

Vantiamo una completa gamma di carrelli di prestiro motorizzati di ultima generazione per ottimizzare e ridurre il consumo di film estensibile per avvolgere i pallet.

Abbiamo adottato soluzioni tecniche che permettono di installare i sistemi con riduzione dei tempi e costi rispetto a macchine tradizionali, riduzione degli ingombri, facile accesso alle zone che richiedono manutenzione.

 ATLANTA STRETCH S.p.A is a company specialized in development, production and sales of semi-automatic and fully automatic stretch wrapping machines.

A range of evolved spool carriages with power stretch system of latest generation optimize and reduce stretch film consumption in pallet unitization.

We have introduced in the machines several technical solutions allowing their installation in reduced time and costs compared to traditional machines, reduction of space, easy access to area with maintenance needs.

 ATLANTA STRETCH S.p.A a pour activité la conception, la construction et la commercialisation de machines automatiques et semi automatiques pour le banderolage de charges palettisées par film étirable.

Nous pouvons nous vanter d'une gamme complète de chariots de pré étirage motorisés et asservi de dernière génération pour optimiser et réduire la consommation de film étirable.

Nous avons adopté des solutions techniques qui permettent d'installer très facilement notre matériel avec une réduction importante des temps de montage par rapport aux machines traditionnelles.

Nous avons également travaillé sur la réduction des encombrements et sur la facilité d'accès aux zones d'entretien.

 ATLANTA STRETCH S.p.A ist ein Unternehmen, das im Bereich der Verpackung und Transportsicherung tätig ist.

Der Schwerpunkt des Unternehmens liegt in der Entwicklung, Konstruktion und Vertrieb von halb- und vollautomatischen Wicklern für Stretchfolie.

Weiter können wir eine Reihe motorisierter Vordehnsysteme der letzten Generation aufweisen, dies ermöglicht den Folienverbrauch sowie die Verpackungskosten zu senken. Hierbei wurde besonders auf eine kompakte Bauweise geachtet um die Installationszeit zu verkürzen, Kosten einzusparen und eine einfache Zugänglichkeit zu ermöglichen um die notwendigen Wartungsarbeiten durchzuführen.



 ATLANTA STRETCH S.p.A es una empresa que se dedica de la proyectación, construcción y comercialización de máquinas automáticas y semiautomáticas para el envolvimiento de los palets con film extensible.



Son máquinas patentadas por su exclusividad.

Tenemos una completa gama de carros de pre-estiro motorizados de última generación, para optimizar y reducir el consumo del film extensible para envolver el palet.

Hemos adoptado soluciones técnicas que nos permite su instalación con reducción de coste y tiempo con respecto a las máquinas tradicionales, reducción del espacio, fácil acceso a las zonas que requieren mantenimiento.

# OMEGA PRS

-  L'unica macchina a prestiro esterno, che non utilizza contatti elettrici sull'anello o altri sistemi complicati e costosi di generazione di corrente. E' in grado di raggiungere una velocità di 140 pallet /h.  
Disponibile anche in versione 2 bobine.
-  The only machine with external pre-stretch drive system, without electric sliding contacts/ slip rings or other complex and expensive solutions like electric generator. Available for output capacity up to 140 pallet /h.  
Also available with double reels.

-  L'unique machine à motorisation externe du pré-étirage, qui n'utilise pas de contacts électriques sur l'anneau ou d'autres systèmes compliqués et coûteux de génération de courant.  
Possibilité d'atteindre une cadence de 140 pal. /h.  
Disponible également en version 2 bobines.
-  Die einzige Maschine Weltweit die das Vordehnsystem über eine aussen montierte Einheit steuert. Dadurch keine elektronischen

Bauteile, Schleifringe sowie kein Generator auf dem Ring benötigt. Erreicht bis zu 140 Paletten/Stunde Auch als Doppelkopf Variante erhältlich.

-  La única maquina con pre-estiro externo, que no utiliza contactos eléctricos en el anillo o sistemas complicados y costosos de generación de corriente.  
Esta preparada para alcanzar una velocidad de 140 palets/h.  
Disponible también en versión de dos bobinas.

## OMEGA PRS DH







-  Sistema di pre-stiro motorizzato del polietilene **OMEGA PRS**.  
La bobina di polietilene può avere dimensioni Jumbo (40 Kg) e quindi una autonomia 3 volte superiore a quelle standard.  
Nella foto in alto, versione OMEGA PRS a 2 bobine.
-  Motorized pre-stretch system **OMEGA PRS**.  
Available with Jumbo reel (40 Kg).  
This solution increases the operating time between stops compared to the standard reel by almost 3 times.  
OMEGA PRS with double reels.
-  Système de pré-étirage motorisé du film **OMEGA PRS**.  
La bobine peut être une jumbo 40 kg pour une autonomie 3 fois supérieure à une standard.

Photo ci-dessus OMEGA PRS à 2 bobines.

-  Motorisiertes Folien Vordehnsystem **OMEGA PRS**.  
Die Folienrolle kann bis zu (40 Kg) betragen und dadurch eine 3 fache länger Laufzeit als bei Standardrollen.  
Siehe Foto oben.
-  Sistema de pre-estiro motorizado del polietileno **OMEGA PRS**.  
La bobina de polietileno puede ser utilizada en Jumbo (40Kg) con una autonomía 3 veces superior a la estándar.  
En la foto version Omega PRS 2 bobinas.



-  Sollevatore Pallet.
-  Pallet Lifter.
-  Releveur de charges.
-  Paletten Hubvorrichtung.
-  Elevador palet.



Touch Screen





- 🇮🇹 OMEGA PRS con TOP COVER.
- 🇬🇧 OMEGA PRS with TOP COVER.
- 🇫🇷 OMEGA PRS avec dépose de coiffe TOP COVER.
- 🇩🇪 OMEGA PRS mit Deckblattaufleger.
- 🇪🇸 OMEGA PRS con TOP COVER.

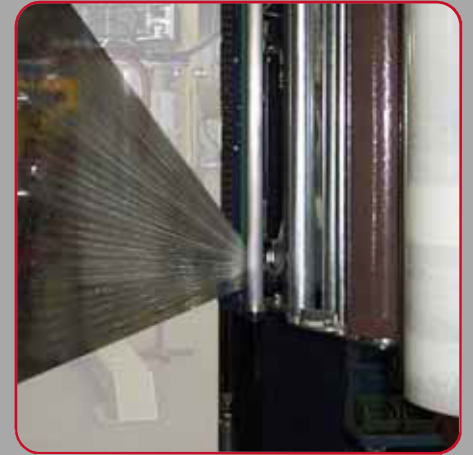
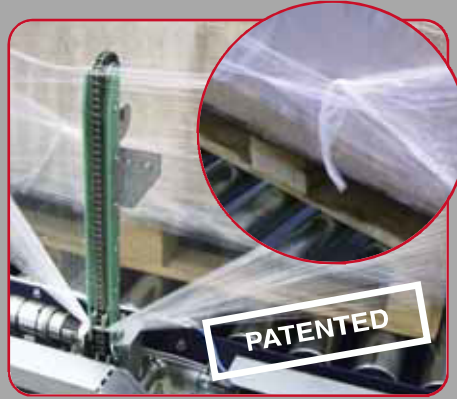







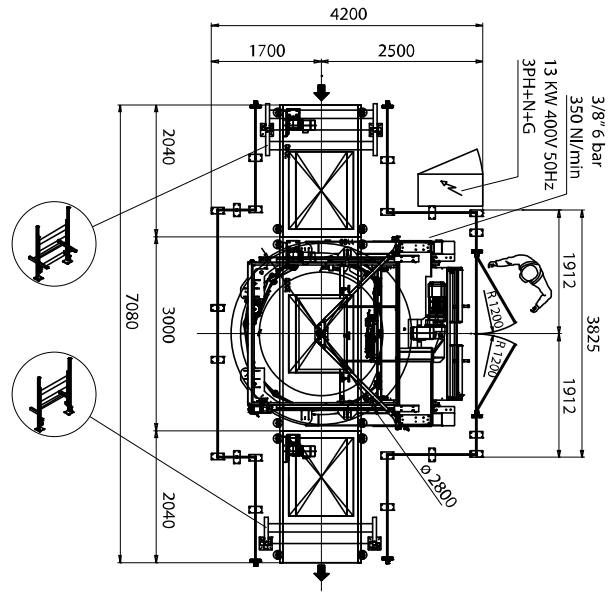
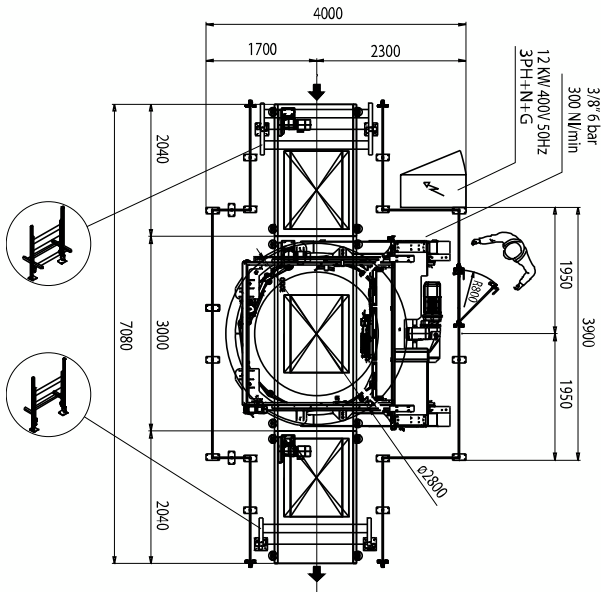
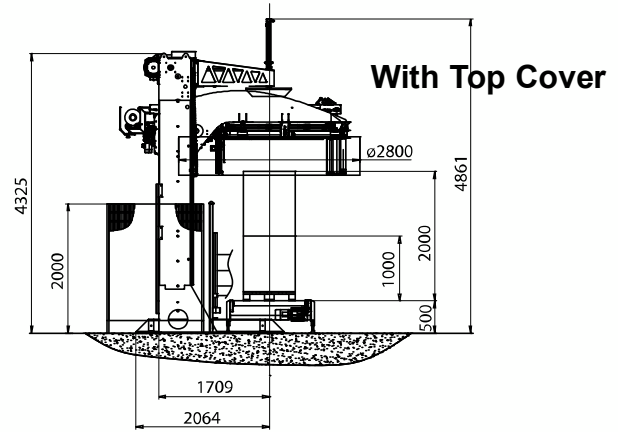
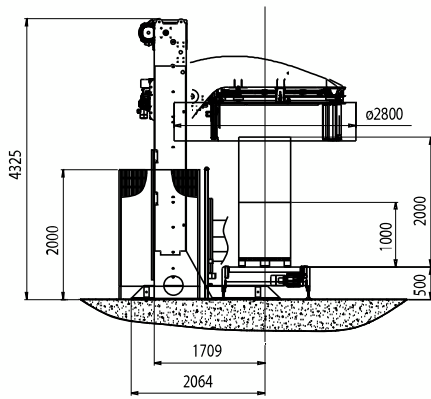



- 🇮🇹 Sistema pinza taglio saldatura del film estensibile autoregolante per qualsiasi dimensione del pallet.
- 🇬🇧 Film cut, clamp and weld unit self adjusting for any size of pallet.
- 🇫🇷 Système de pince, coupe et soudure du film étirable à réglage automatique pour toutes dimensions de la palette.
- 🇩🇪 Selbsteinstellendes Folienende Verschweißsystem passt sich auf sämtliche Palettengrößen automatisch an.
- 🇪🇸 Sistema corte pinza soldadura del film extensible autorregulable para cualquier dimensión de palet.





- 🇮🇹 Sistema pinza taglio del film estensibile con inserimento del lembo finale nell'ultimo avvolgimento di film. Utilizzabile anche con film macroforato.
- 🇬🇧 Clamp, cut and tuck in unit for threading the stretch film tail inside the wrap. Suitable also for net film.
- 🇫🇷 Système automatique de pince et coupe du film étirable avec blocage de la queue de film par insertion sous le tour précédent. Utilisable également avec du film macro perforé.
- 🇩🇪 Das Folienende wird am Ende des Wickelzyklus abgeschnitten und eingeschlagen. Geeignet auch für Netzfolien.
- 🇪🇸 Sistema pinza corte del film extensible con introducción del corte en la última envoltura de film. También utilizable con film macroperforado.

- 🇮🇹 Sistema a corda: Permette di ridurre l'altezza del film formando un cordone che assicura una più efficiente stabilizzazione del carico.
- 🇬🇧 Roping System: Reducing the film width to form a rope to ensure more effective load stabilisation.
- 🇫🇷 Système de réduction de laize pour aération ou création d'un cordon assurant une stabilisation supérieure de la charge.
- 🇩🇪 Schnurvorrichtung: Reduzierung der Folienbreite zur Schnur um eine bessere Stabilisierung der Ladung zu gewährleisten.
- 🇪🇸 Sistema cuerda: Permite reducir la altura del film formando un cordón que asegura con más eficacia la estabilidad de la carga.



-  Sistema automatico di tensionamento cinghia rotazione anello con visualizzazione allarme su Display.
-  Automatic system for controlling belt rotation tension of the ring with alarms displayed on Display.
-  Système automatique de tension de la courroie d'entraînement de l'anneau avec visualisation sur l'afficheur.
-  Automatische Systeme zur Kontrolle der Spannung des Ringdreihemens mit Alarme angezeigt im Display.
-  Sistema automatico señalización tensionamiento cinta rotacion anillo con señalización de alarma en el display.

-  Sistema automatico anticaduta anello.
-  Automatic system to lock out the ring for access and maintenance.
-  Système automatique anti chute de l'anneau.
-  Automatische Fallsicherung für den Ring.
-  Sistema automatico anticaida anillo.

-  Pressore tenuta pallet a corsa illimitata.
-  Pallet holding presser without travel limitation (optional).
-  Plateau stabilisateur à course illimitée.
-  Paletten Niederhalter mit unbegrenztem Verfahrensweg.
-  Presor palet de carrera ilimitada.

**Dati Tecnici****OMEGA PRS****Dimensioni prodotto**

Altezza linea alimentazione standard	500 mm ± 50	Dimensione max pallet	1200 x 1200 mm
Velocità massima rotazione anello	65/70 rpm		1300 x 1100 mm
Potenza totale installata	12 Kw - 13 Kw con Top	Dimensione min. pallet	600 x 800 mm
Tensione alimentazione standard	400 V – 50 Hz – 3 F+N+T	Altezza std pallet	2200 mm
Protezione impianto elettrico e motori	IP 54		
Pressione esercizio	6 bar		
Rapporto di pre-stiro	Min. 160% - Max. 300%		

**Technical Data****OMEGA PRS****Product Dimensions**

Conveyor height std	500 mm ± 50	Max pallet dimensions	1200 x 1200 mm
Maximum ring rotation speed	65/70 rpm		1300 x 1100 mm
Total power installed	12 Kw - 13 Kw with Top	Min pallet dimensions	600 x 800 mm
Standard power supply	400 V – 50 Hz – 3 PH+N+G	Std pallet height	2200 mm
Protection on electric system & motors	IP 54		
Operating pressure	6 bar		
Pre-stretch ratio	Min. 160% - Max. 300%		

**Données Techniques****OMEGA PRS****Dimensions Produit**

Hauteur convoyage standard	500 mm ± 50	Dimension max palette	1200 x 1200 mm
Vitesse maxi de rotation	65/70 t/min		1300 x 1100 mm
Puissance installée	12 Kw - 13 Kw avec Top	Dimension min. palette	600 x 800 mm
Tension alimentation standard	3 x 400 V + N + T / 50 Hz	Hauteur std palette	2200 mm
Protection électrique	IP 54		
Pression air	6 bar		
Pré-étirage	Min. 160% - Max. 300%		

**Technische Daten****OMEGA PRS****Produktmaße**

BoDENhöhe Standard	500 mm ± 50	Maximalmaße der Palette	1200 x 1200 mm
Max. Drehgeschwindigkeit des Tisches	65/70 rpm		1300 x 1100 mm
Installierte Gesamtleistung	12 Kw - 13 Kw mit Top	Minimalmaße der Palette	600 x 800 mm
Versorgungsspannung Standard	400 V – 50 Hz – 3 PH+N+G	Std Höhe der Palette	2200 mm
Schutz der Elektroeinrichtung und Motoren	IP 54		
Arbeits-Druckleistung	6 bar		
Vordehnung	Min. 160% - Max. 300%		

**Datos Técnicos****OMEGA PRS****Dimensiones del producto**

Altura línea transportadores	500 mm ± 50	Dimensiones máximas del palet	1200 x 1200 mm
Velocidad máxima rotación de anillo	65/70 rpm		1300 x 1100 mm
Potencia total instalada	12 Kw - 13 Kw con Top	Dimensiones mínimas del palet	600 x 800 mm
Tensión de alimentación estándar	400 V – 50 Hz – 3 F+N+T	Altura std del palet	2200 mm
Grado de protección eléctrica y motores	IP 54		
Presión nominal	6 bar		
Relacion de pre-estiro	Min. 160% - Max. 300%		

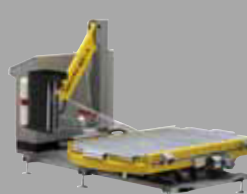
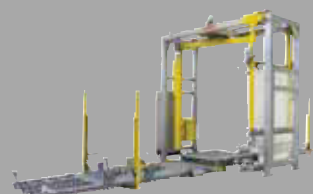
**SFERA****SYNTHESI****MYTHO****MYTHO-A****REVOLUTION**

**ATLANTA**  
STRETCH

ATLANTA STRETCH S.p.A  
Via Chiesa di Camerano, 30  
47824 Poggio Berni (Rimini)  
ITALIA

Tel. +39 0541 627145  
Fax +39 0541 627220  
[www.atlantastretch.com](http://www.atlantastretch.com)  
[sales@atlantastretch.com](mailto:sales@atlantastretch.com)

Atlanta Deutschland GmbH  
Atlanta Stretch Sweden AB  
Atlanta Packaging SA - Spain  
Atlanta Packaging Ltd - UK  
Atlanta France Sarl  
Atlanta Packaging Systems Australasia